



折后尺寸：120*200mm
 纸张克重：太阳双胶纸 100g
 印刷色值：四色
 装订方式：风琴折
 封面：此页为封面（仅供参考）



要求：

- 模切走位 $\leq \pm 1\text{mm}$
- 色相正确、印迹牢固、
- 套印准确、各色套印
- 不露杂色，套印误差 $\leq 0.1\text{mm}$
- 符合环保标准，通过 RoHS 认证

* 本品牌及其所使用的标志、名称、图像以及所有内容设计，其版权均为本公司所有，未经授权任何组织、个人、商业团体不得擅自使用、翻印，本公司保留追究其法律责任的权利！

1403011212	V0.2	新增电工胶布、点火图示； 修改开机方式为二选一		屈思怡	张晓惟	2025.08.05
1403011212	V0.2	/	EcoFlow Alternator Charger Plus 1000	Haina	张洁婷	2025.05.29
产品料号	版本号	更新内容	产品名称	设计师	文案	更新时间

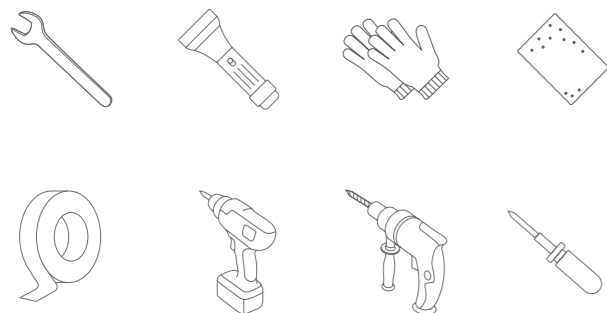
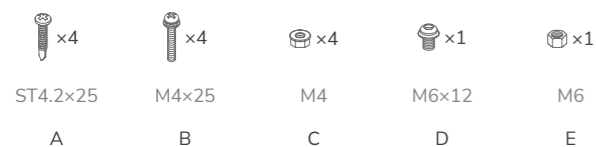
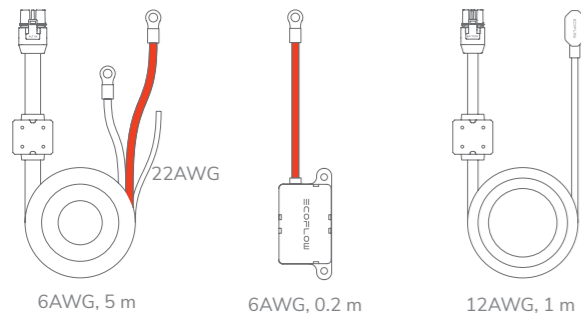
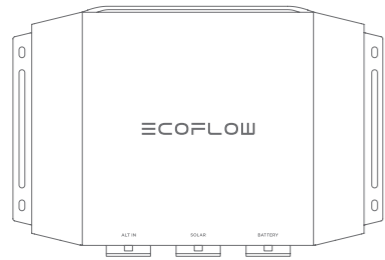

1

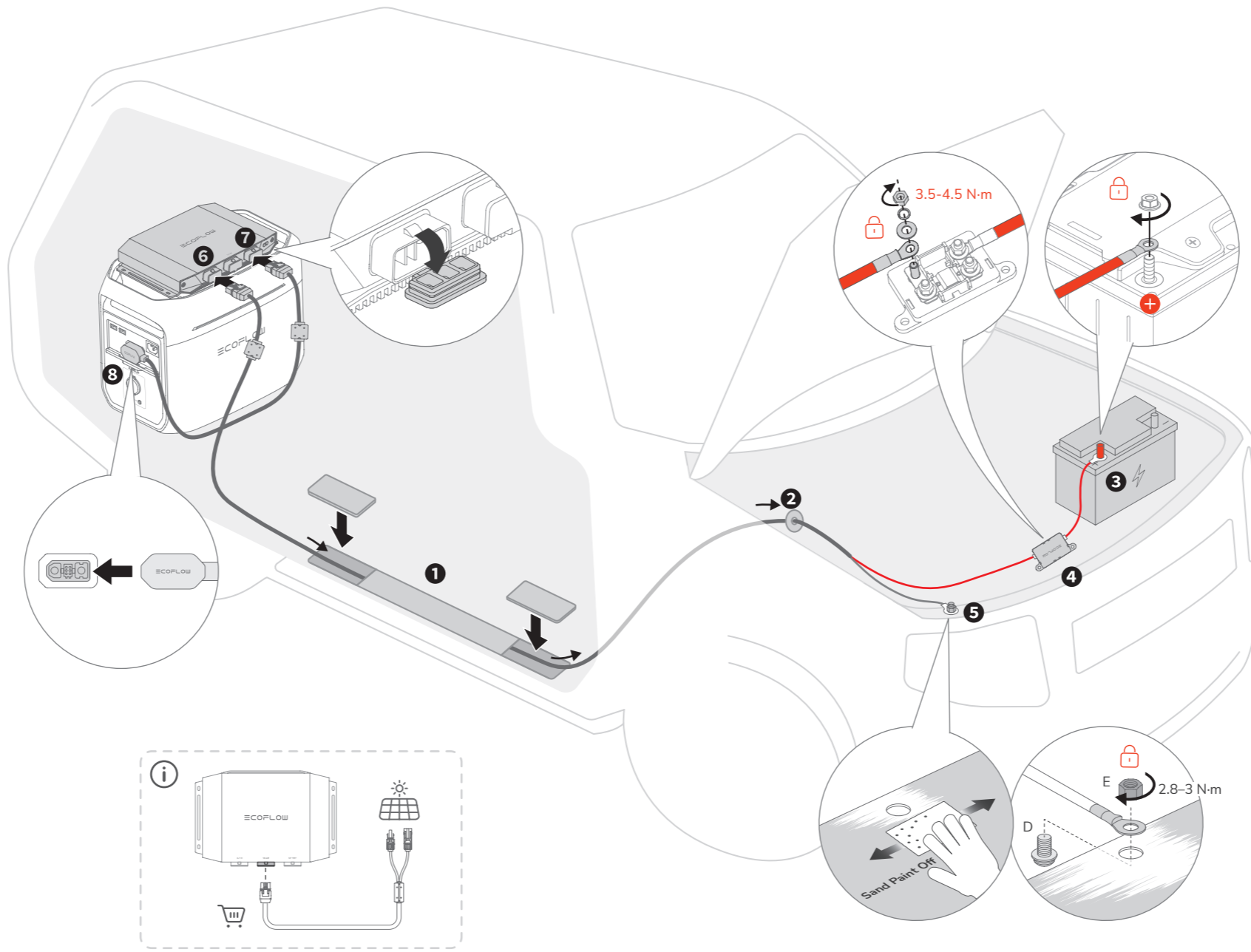

2

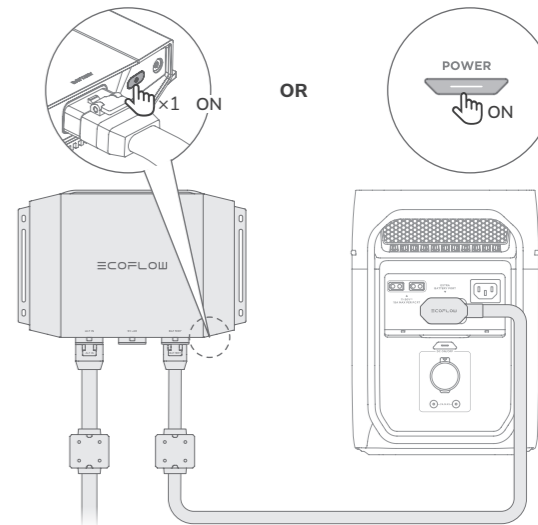

3



4

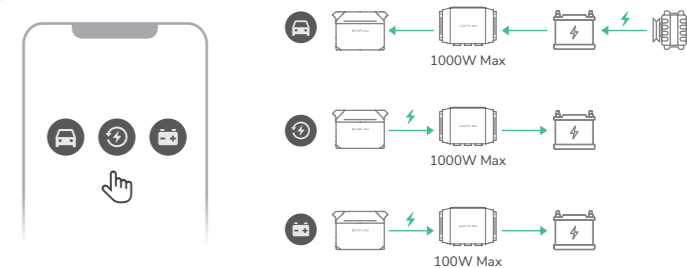

QUICK START GUIDE

V1.0

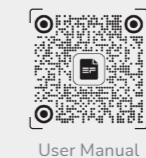
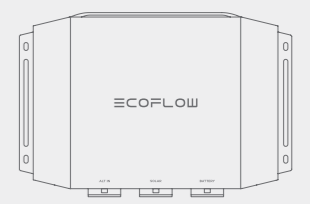
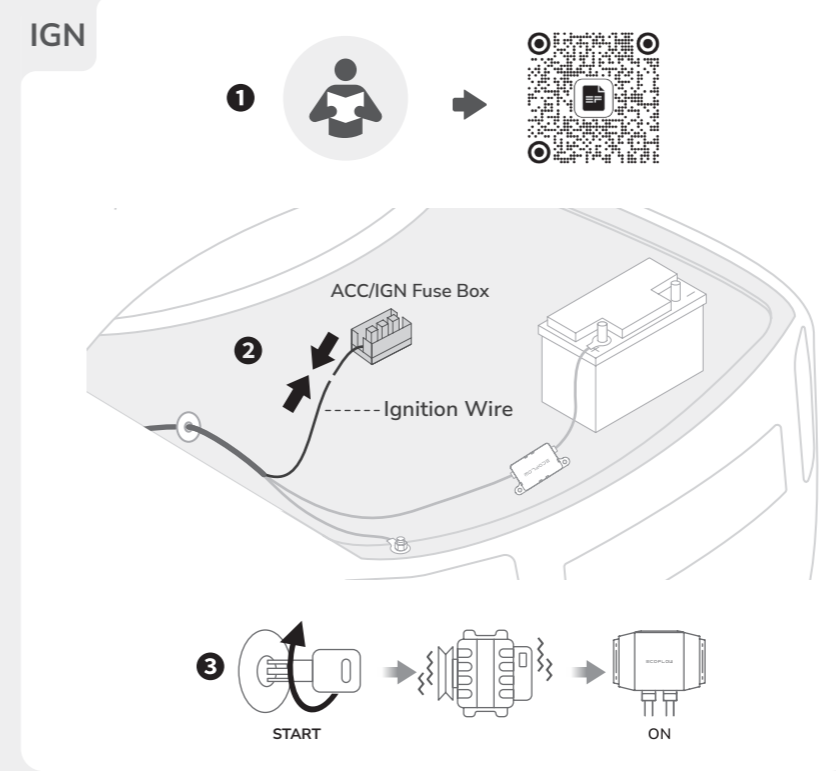
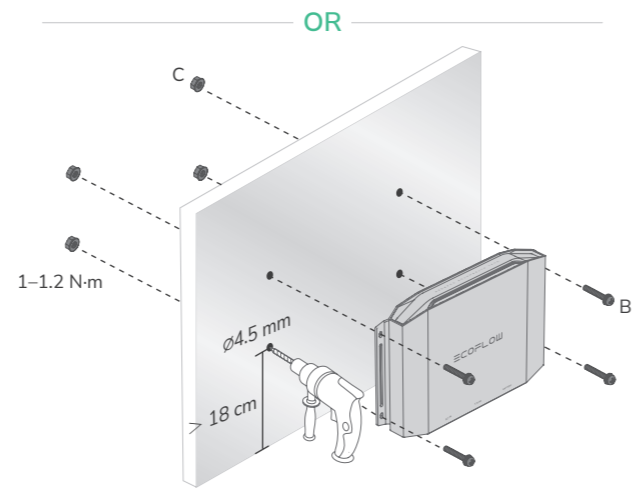
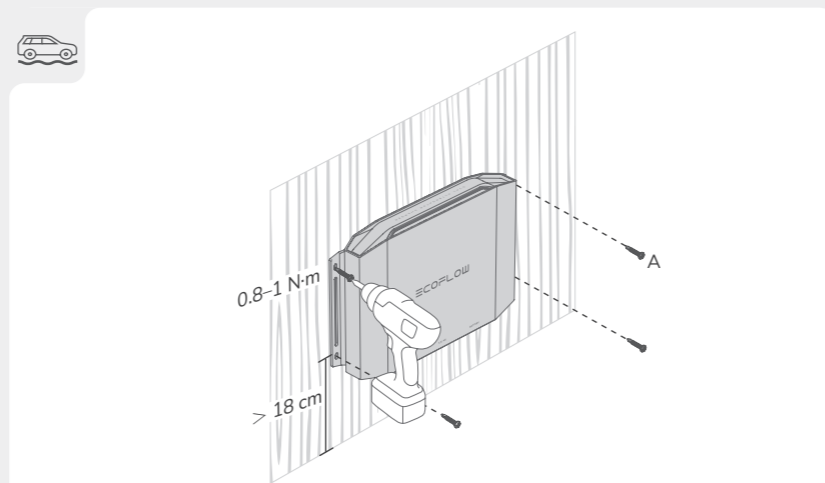
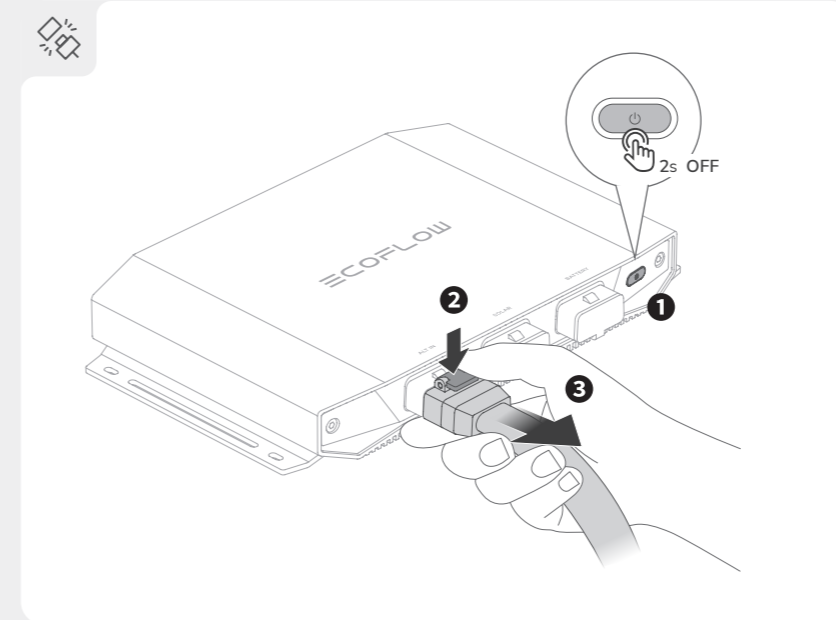
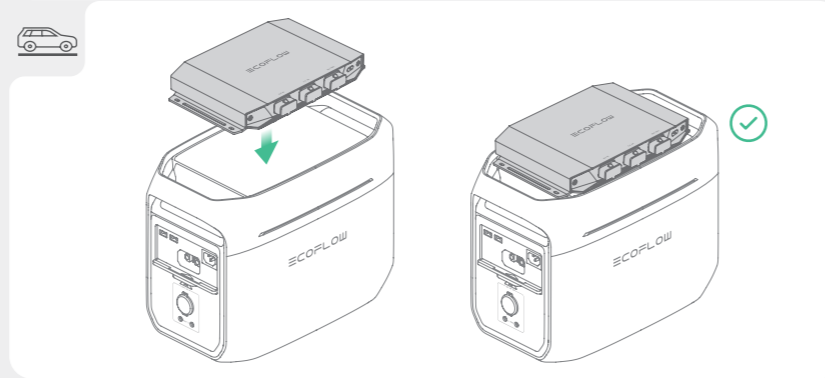

EcoFlow Alternator Charger Plus 1000

For more details, check the latest user manual or related documents.
<https://www.ecoflow.com/support/download>
 Images in this document are for demonstration only.

